

Article number: 201242620

Description: E+G
Pin with axial lock GN 124.2-6-20

Measures

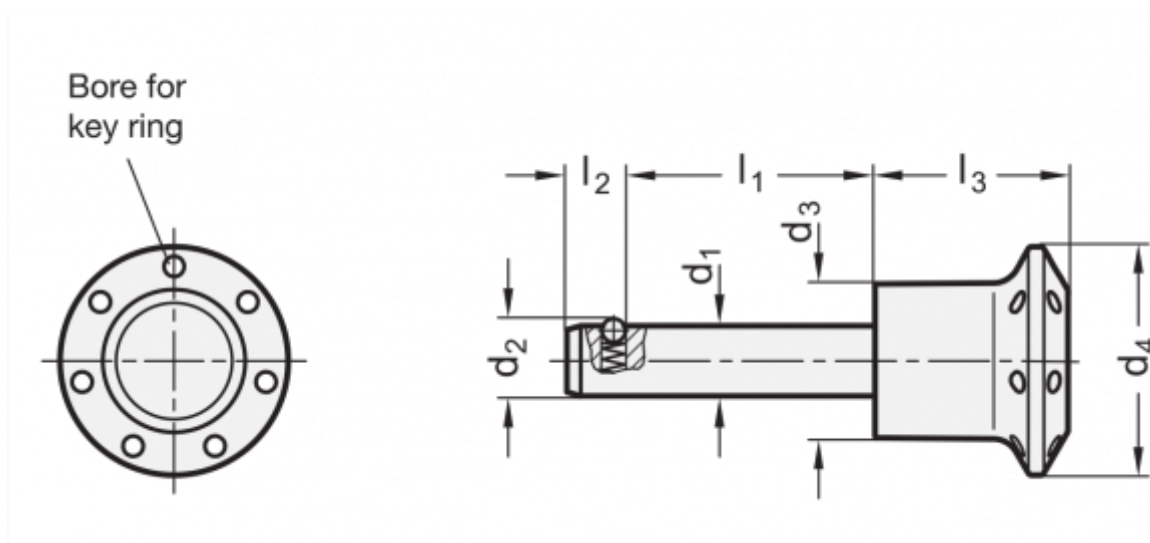

Axial grasping power on pins N = 8

Bore for pin D12 = 6

d1 = 6

d2 = 6.5

d3 = 14.5

d4 = 25

Dividing power (double) in kN = 22

l1 = 20

l2 = 5.0

l3 = 22.5